

emv

Hyperion X9

3-in-1 Imaging System



myray
new comfort
in digital imaging



Hyperion X9, just right for me.

The present and the future of my work. In three dimensions. Hyperion X9 offers me multiple possibilities and a full range of functions to aim for the best, at all times.

MyRay, Just right for you.



reddot design award
winner 2013

X9 generation: full empowerment.

All the possible choices in one touch. Hyperion X9 adapts to your work, optimizes your time, satisfies your needs. A hybrid platform with exceptional performances.

The best way of distinguishing your work. In full harmony with MyRay's philosophy, Hyperion X9 unites advanced technology and simplicity of use, thereby ensuring you excellent diagnostic analyses in a short time. Try out a new level of efficiency thanks to the automatic alignment of the 2D and 3D detectors. Adapt the platform to your needs: three exceptional solutions, easy to adapt and flexible. One system, multiple functions. Choose the best, Hyperion X9 offers you a wide range of 2D analyses, cephalometric projections and all the best of 3D technology.

All in one.

- 12 configurations
- Hybrid technology
- Rapid update
- Relocatable PAN/CEPH detector
- Automatic selection of the dedicated 2D and 3D detectors (Patented)



CB3D. With the Cone Beam 3D technology, a single scan generates an infinity of high definition data (75 μm) for the sake of a new method of work. Enlarge your diagnostic imaging. The full dentition from perspective in HD.



CEPH. Ultra rapid scan, within an ultra compact space. Full choice of teleradiographic images thanks to the dedicated programs. Maximum results with a relocatable detector for cephalometric projections, capable of being hooked onto the teleradiographic arm and fastened onto a safety device.

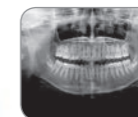

PAN. The advanced kinematics and the dedicated 2D detector make it possible to obtain exceptional HD panoramic imaging and a broad spectrum of analyses, such as orthogonal projections of the dentition, bitewing X-rays and multi-angle views of the temporomandibular joints. Automatic selection between the 2D and the 3D detectors.

Full 3D. Your present.

Widen your vision towards another dimension. 3D is the answer to your diagnostic needs, for the sake of a new universe of possibilities, at the highest level of efficiency.

The future of your clinic begins now. Hyperion X9 provides you with the only possible answer to your needs: the best one. 3D becomes an indispensable, flexible, efficient tool. Transcend the limits: greater potential, more diagnoses, more patients. Only Hyperion X9 offers you faster choices, maximum results, maximum satisfaction.

Imagine your tomorrow. Create your future. Now.

- Extraordinary performances within short times
- Cone Beam 3D HD technology
- Diagnostic efficacy
- Satisfied patients, fond patients

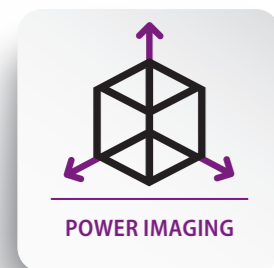

3D is evolution, 3D is necessity, 3D is more efficient diagnoses and more satisfied patients. Hyperion X9 brings into your clinic the three-dimensional diagnostic state-of-the-art, so as to lend value to your work and satisfy the most complex clinical needs, by offering maximum care to the patient.



Full vision: perfection in details.

Why choosing when you can have everything? One detail, one world at your disposal. Hyperion X9 adapts to you and guarantees you highest definition images. Every detail, from every viewpoint, for the sake of complete, effective and quick diagnoses.

The full FOV guarantees you scans of the whole dentition, the standard FOV allows you a scan of the single dental arch, the craniostat ensures you maximum stability, for the sake of unmatched results. Choose the future now: a single scan for multiple results, a single diagnosis for every detail. The craniostat ensures the correct positioning, the FOV enables complete investigations: the perfect formula for an ideal workflow. The right technology, for every need. Transcend the limits of your clinic with a faster, more flexible, more exceptional work.

HD perfection.

- Full FOV (field of view) up to 11 cm of diameter
- High Definition (75 µm Voxel)
- Low X-ray dose

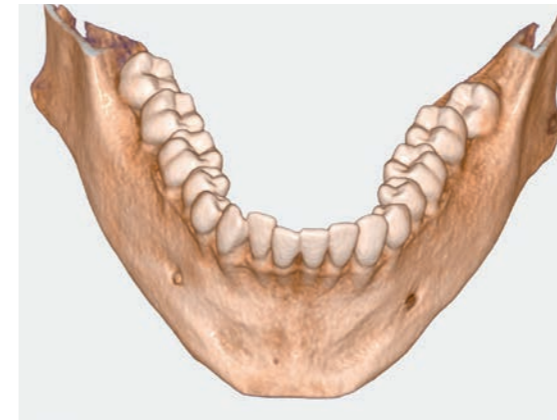

FULL DENTAL ARCH IN HD

The scan of the entire dental arch is a necessity for your work, a step forward towards efficiency. That is why Hyperion X9 adopts a FOV up to 11 cm of diameter, in order to allow us complete diagnoses with maximum efficiency. You will thus have at your disposal the whole dentition, including the complete roots of the third molars (the wisdom teeth) and the surrounding bone structures. No limit to the planning of multiple implants, even with the use of surgical guides.



LOW DOSE AT 360°

Volumetric acquisition with a full 360° scan capable of eliminating the artefacts of the resulting image. High resolution at extremely low X-ray doses: excellent quality, detailed particulars, fast diagnosis. Hyperion X9 ensures you excellence with a maximum voxel resolution of 75 µm across the full arch. The constant potential generator with pulsed mode emission automatically optimizes the parameters according to the patient, thereby ensuring maximum results with minimum exposure (3.6 s).



INNOVATIVE ERGONOMIC CRANIOSTAT

Stability and comfort: choose the best with as many as 7 support points for the sake of a stable patient under all circumstances. With a seat for the chin, the adjustable self-locking forehead support and the replaceable bite block, the positioning system has never been so simple and effective. Perfect images in every situation (3 patent pending).

Multiple FOV

Full 3D. FOV experience.

Only Hyperion X9 offers you an innovative FOV, unique of its kind since it is dynamic. The best for your clinic, excellence in your diagnoses.

Extend your vision, broaden your work: with the innovative function of Extended View beyond 11 cm of diameter, you will have a FOV (field of view) up to 13 cm of height. For the sake of complete analyses, optimized upper and lower jaw and maxillary sinus scans. Hyperion X9 does not offer you a mere "stitching" of two datasets generated by the software, but a fully automatic process, for the sake of a vertically extended field of view ensuring high image quality. A single acquisition, a universe of details: double scan, single volume, moderate dose.

Extend your view.

- Extended View (Patent Pending)
- Dynamic FOV
- Intelligent collimation



FOV 11 X 13 CM

For the sake of full analyses of the whole dentition, upper and lower jaw, including the maxillary sinuses and the upper airways. All you need in a single acquisition: double scan, single volume, moderate dose since it is not repeated over the same area. The diagnoses you are looking for, at the highest quality.



FOV 11 X 8 CM

For full volumetric examinations of the two dental arches, including the roots of the third molars and surrounding bone structures. For the dedicated study of the superior dental arch, including the maxillary sinuses, and the surrounding bones: useful for a correct pre-implant diagnostics even in complex cases.



FOV 11 X 5 CM

Perfect for a full limitless diagnostics. For the planning of multiple implants and treatments with surgical guides. The diameter of 11 cm and the height of 5 cm enable a thorough study of the arches from the occlusal surface to the roots, including the third molars and the adjacent anatomical structures, such as the mandibular canal or the surrounding bone.



FOV 8 X 8 CM

For a study of the full dentition in children, 8 cm of diameter are enough. Besides, the height of 8 cm ensures the possibility of securing the antagonist teeth as well as assessing pathologies in the maxillary sinuses of adult subjects.



FOV 8 X 5 CM

For an analysis of the whole dental arch in children or for localized studies of limited districts, such as a full hemi-arch or the frontal dentition (up to tooth #6) in an adult. Focus your vision and reduce the X-ray exposure in a region of greater diagnostic interest.



FOV 5 X 5 CM

For the planning of single implants, complex dental extractions, localized in-depth diagnostics, specific endodontic procedures, or for the study of the temporomandibular joint. Minimum dose. Great details.

Clinical 3D Cases

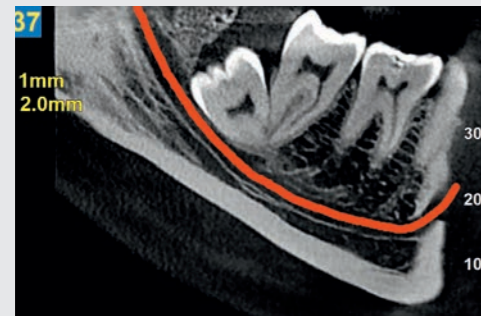

Section obtained from the volumetric data

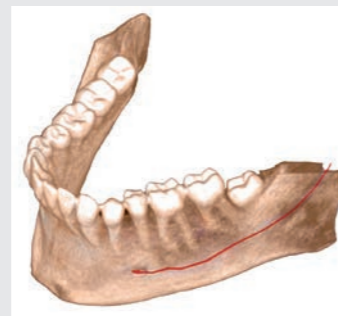

3D display of mandibular canal



Axial section on the roots of the mandibular molars

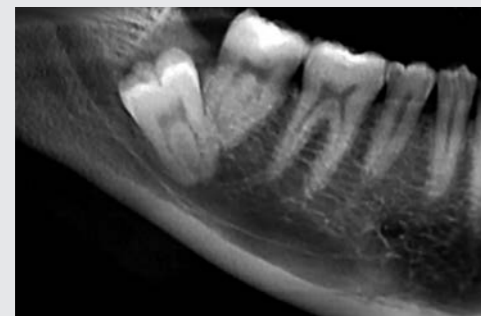

Two-dimensional projection

Full dental arch: relationship of roots with mandibular canal

In an adult of medium build, the distance between the third molars on the left and right, together with the respective roots, the alveolar process and the surrounding cortical bone, is at least 9 cm. A FOV with a lower diameter than 10 cm would not make it possible to fully analyze the entire arch, especially useful for highlighting the relationship of the dental roots with the mandibular canal.

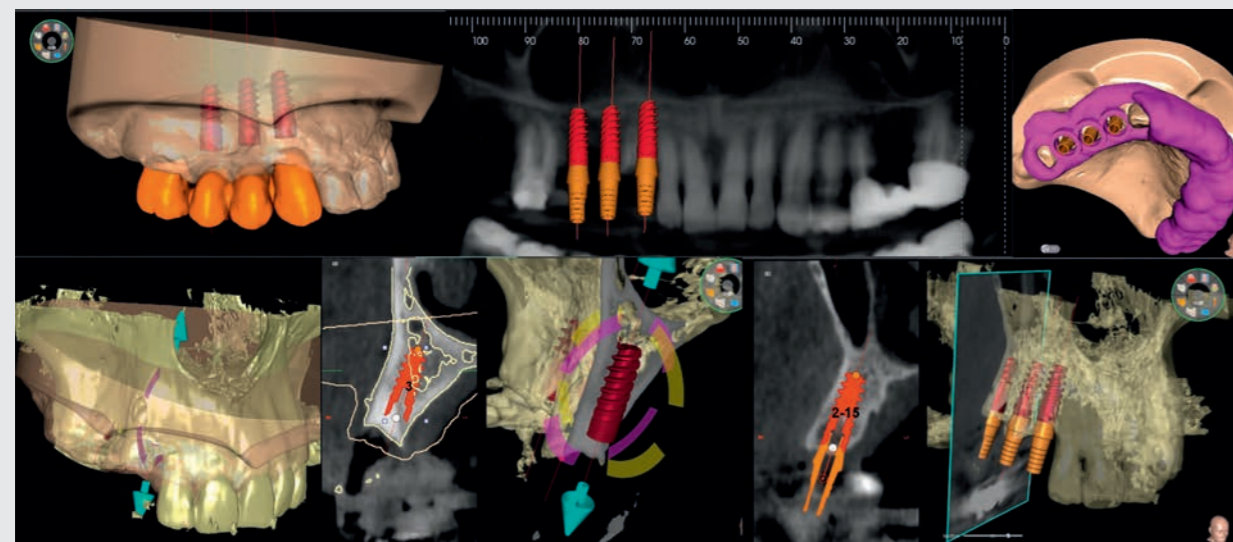

Creation of surgical guide thanks to combined analysis of volumetric data with digital impression

Advanced Implant Planning

With Advanced Implant Planning, you can determine the exact position of the implant directly on the 3D model, on the strength of the finalized prosthetic project imported by the CAD. All in 3D. Assess the bone quantity as well as the surrounding anatomical structures, such as the mandibular canal, by defining a minimum safety distance. Quantify the volume which is necessary for any maxillary sinus lift. Export to the STL file format the bone model and the implants, so as to print the surgical guide.

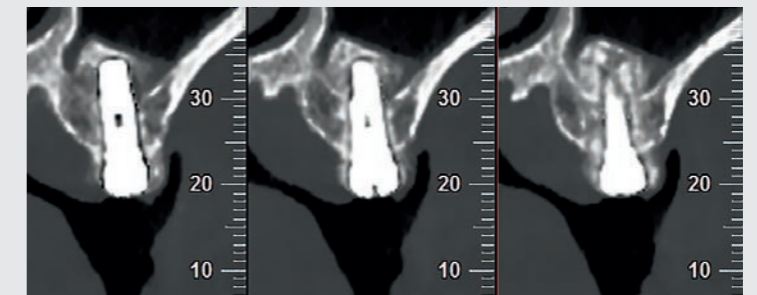
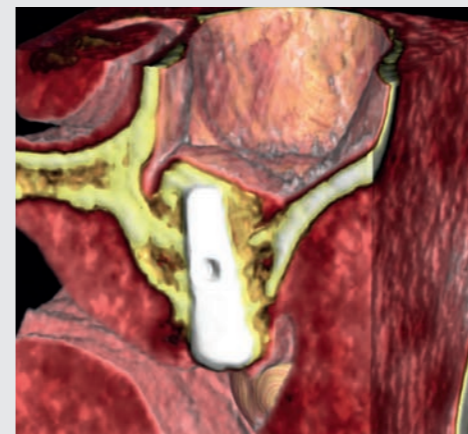
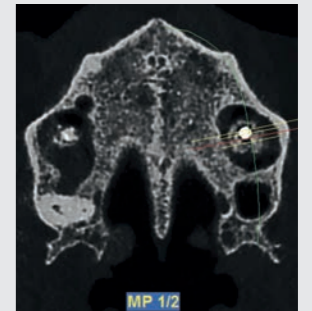
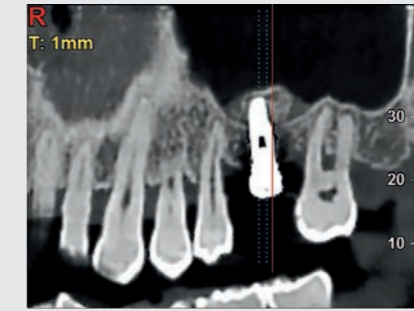
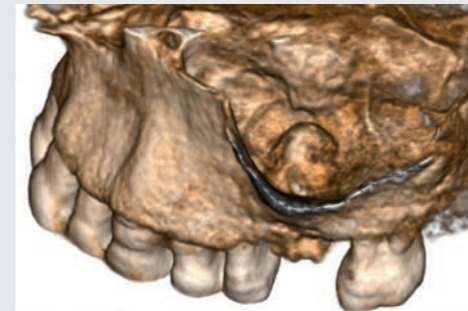

Implant with maxillary sinus lift

Series of images and data obtained through CB3D technology, acquired immediately after the operation, which show the exact relationship between implant, bone, membrane of the lifted sinus and mucosa.

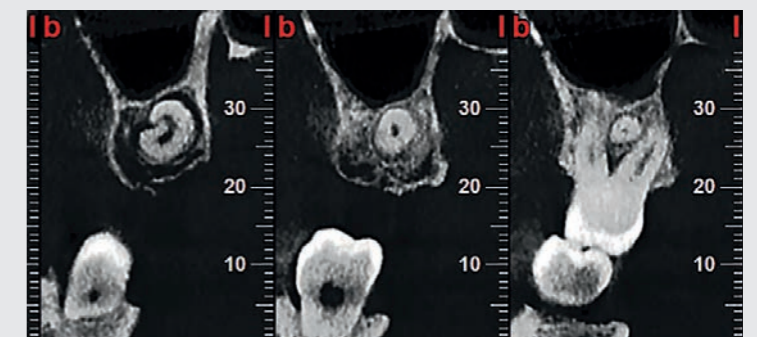
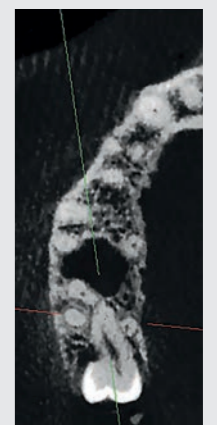
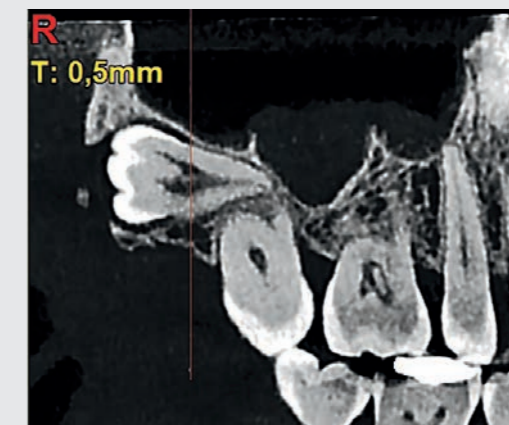

Third molar, maxillary included

Full radiographic examination which shows in detail the intricate structure of the roots; in order to achieve this level of diagnosis, it is not necessary to carry out multiple X-ray projections: a single examination is enough.

Full perfection in 2D.

Perfection in two dimensions. Hyperion X9 elevates to excellence the quality of panoramic and cephalometric examinations, all of them available for your clinic.

Hyperion X9 offers an efficient dedicated detector for 2D diagnostics (PAN/CEPH), relocatable and releasable, fastened onto a safety device; with the possibility of adding a second detector so as to carry out cephalometric projections. Try out the wide range of two-dimensional exams, such as orthogonal projections of the dentition, bitewing X-rays and advanced views of the temporomandibular joint. **All possibilities, one touch.**

- Optimized focal layer
- Uniform enlargement of all projections
- Advanced kinematics (3 engines):
2 translations, 1 rotation
- Fast positioning, Face To Face,
4 Laser traces
- Lower radiogenic dose

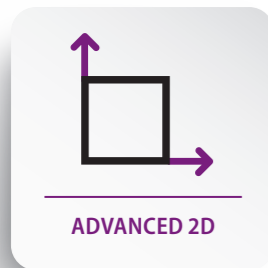

The solidity of 2D. In a new dimension, Hyperion X9 offers you the best result in every field, in every examination, for every need. Constant updates and innovative technology for a sector revolution: a universe of high definition details for a constantly perfect work. Yours.

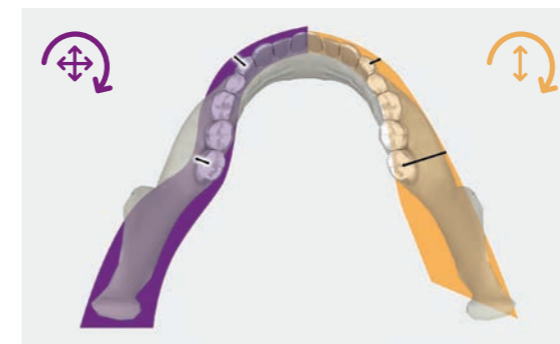

● Hyperion X9	● High-end competitor
Constant magnification	Uneven magnification
1 rotary movement and 2 simultaneous translatory movements	1 rotary movement and 1 simultaneous translatory movement only

ADVANCED KINEMATICS

A highly synchronized kinematics structured around a rotary motion and two simultaneous translatory movements, for purposes of a constant enlargement of all the projections. The optimized focal layer follows the morphology of the patient, for the sake of images always in focus and a universe of high definition details.



FACILITATED POSITIONING

4 laser traces for a fast positioning, with maximum comfort. Absolute precision, unmatched efficiency: the patient feels comfortable thanks to the ergonomic design which enables a direct visual contact during the procedure. The patient is more relaxed, the diagnosis is more serene, the work is perfect.

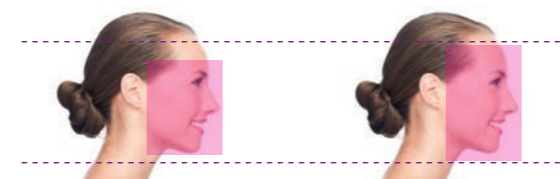

● 18 cm reduced	● 18 cm
Only 49% of irradiated area	60% of irradiated area

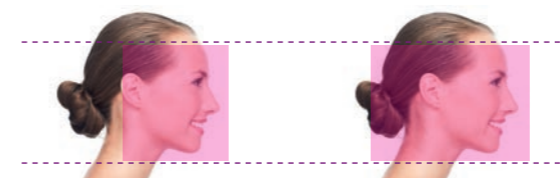

● 24 cm	● 30 cm
80% of irradiated area	100% of irradiated area

INTELLIGENT COLLIMATION

Thanks to the primary servo controlled collimator, it is possible to select the exact area to expose to X-rays (Patented). The secondary collimator for cephalometric projections is integrated into the rotating module, which allows a on-floor footprint with minimum cephalometric arm, freeing in any event a larger space for both operator and patient (Patent Pending).

Full performance.

Many examinations, a single result. The best one. Hyperion X9 is capable of satisfying every diagnostic need of yours thanks to 39 different examinations. Exceptional results and maximum flexibility.

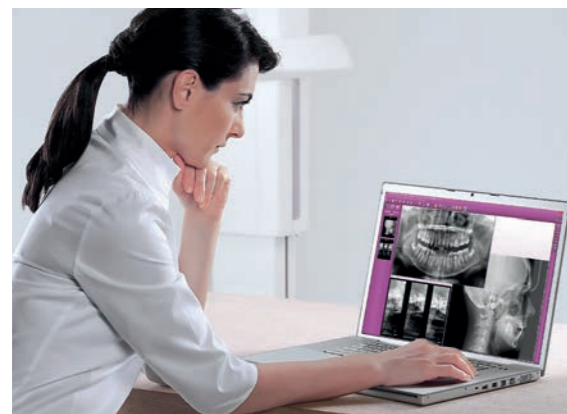

Hyperion X9 offers you the best of 2D programs, from the panoramic exams to the cephalometric ones, with a rapid exposure so as to contain the times and reduce the X-rays dose for the patient's safety. Choose between orthogonal projections of the dentition and bitewing exposures focused on the dental crowns. Study the temporomandibular joints in Posterolateral and Latero-lateral projections even from multiple angles, or analyze the maxillary sinuses. Utilize the QuickPAN function: even faster acquisition procedures for the sake of more serene patients. For every single program, the X-ray data are acquired with a dedicated trajectory and collimation.

Empower your experience.

- 39 2D examinations
- A single craniostat for all the examinations
- HD panoramic images
- QuickPAN
- Bitewing dentition
- Multi-angle TMJ's

PAN

12 PANORAMIC EXAMINATIONS

- HD panoramic and QuickPAN
- Full panoramic and reduced Panoramic for children
- Orthogonal projection for the whole dentition, reduces the overlapping of the dental crowns
- Segments of panoramic imaging and dentition with optimized dedicated projections
- Bitewing exposures in 4 segments limited to the crowns, so as to highlight interproximal caries

TMJ

14 TMJ EXAMINATIONS (WITH OPEN OR CLOSED MOUTH)

- Latero-Lateral projections of both the TMJ's (temporomandibular joints)
- Postero-Anterior projection of both the TMJ's
- Latero-Lateral projections from multiple angles (x3) of a single TMJ
- Postero-Anterior projection from multiple angles (x3) of a single TMJ

SIN

3 EXAMINATION OF THE MAXILLARY SINUSES

- Frontal or left/right side view of the maxillary sinuses

CEPH

10 TELERADIOGRAPHIC EXAMINATIONS (CEPH)

- Latero-Lateral projections, selectable scan length between 18 and 30 cm
- Latero-Lateral projection of reduced height for children, brief scan at a moderate radiogenic dose
- Anterior-Posterior or Posterior-Anterior projections
- Submento-vertex (SMV) projections, including Waters' projections (occipitontal views) and reverse Towne projection
- Projection of the carpus



Clinical 2D Cases



1a



1b



1c



2

Consistently good results

- 1 A sample of three very different morphologies: a child, an adult and an elderly patient benefiting from the HD panoramic projection provided by the Hyperion X9 with increased focal spot.
- 2 Projection of the hemi-dentition achieved with a very low X-ray dose, showing a wealth of clinical detail.



3a



3b

Biting projections

- 3 Biting exposures limited to crowns, to detect interproximal caries, can be a comfortable alternative to intraoral imaging, appreciated by patients with a strong gag reflex.

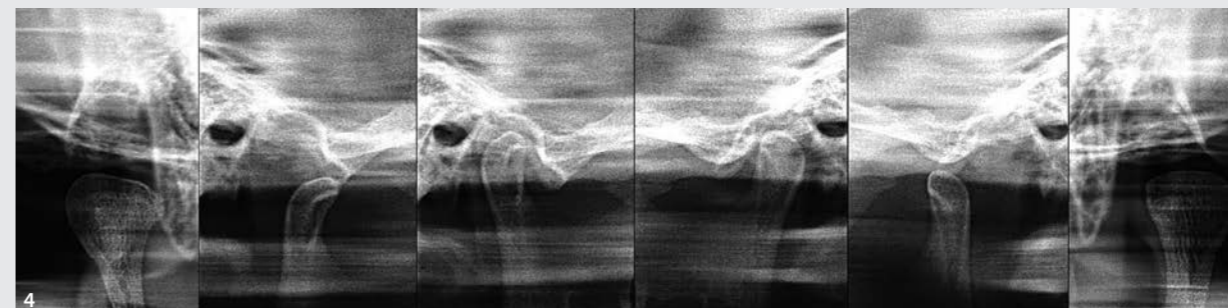

4



R

5



6



7

Specialty radiographs

- 4 A thorough investigation of left and right TMJs, combining Lateral projections of TMJ in open and closed mouth positions and Postero-Anterior projections. Such an outcome is achieved thanks to a precise identification of the position of condyles, using Hyperion's laser guides.
- 5 Frontal view of maxillary sinuses.
- 6 Carpal teleroiography.
- 7 Latero-Lateral teleroiography, highlighting both bony structures and soft tissue profile, suitable for Cephalometry.

Full imaging.

Faster than imagination. Hyperion X9 brings you maximum speed in image sharing. Simple, practical, effective. Under all circumstances.

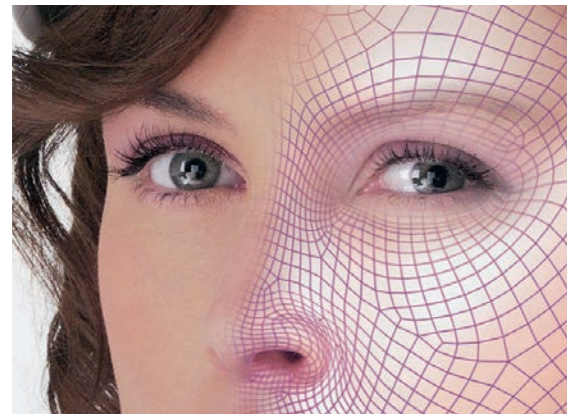

Targeted software and pre-acquisition tools for the best result. What you desire. Hyperion X9 facilitates your work through the innovative patented MRT (Morphology Recognition Technology). Automatically secure the recognition of the patient's morphology for a correct X-ray exposure and an optimal image. With the aid of MRT, there is no need to plan exposure times or technical factors such as the kV or mA level. Hyperion X9 avoids over- or under-exposed images, thereby preserving the quality of your diagnostics and avoiding useless radiogenic doses to the patient (2 Patent Pending).

Our innovation at your service.

- MRT (Morphology Recognition Technology)
- Scout View and automatic repositioning
- Servo controlled patient positioning
- Pluggable onto a tablet

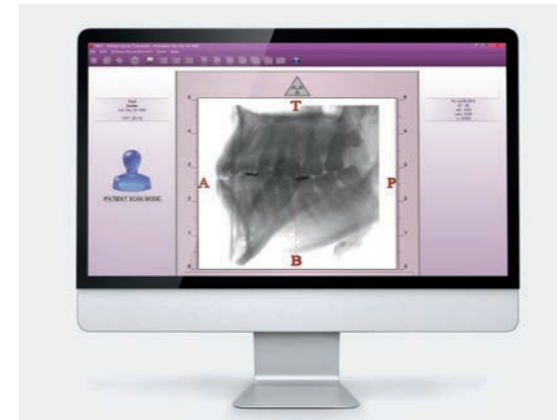

SERVO CONTROLLED PATIENT POSITIONING

The patient remains motionless, while the laser-guided or virtually guided multi-engine mechanism on Scout View positions itself around the patient. Precisely identify the region of interest thanks to the laser pointer or to a 2D (scout) view. Hyperion X9 offers you a servo controlled kinematics, with a simple click you can automatically reposition the FOV according to your adjustments. The acquisition of scout images is carried out with extremely moderate radiogenic doses and eliminates the risk of having to repeat the procedure.



TOUCH-SCREEN CONSOLE ABOARD A MACHINE

Intuitive graphics and direct commands speed up your work by offering to the patient a more relaxing experience. Hyperion X9 is characterized by the simplicity of use and the rapidity of procedures, such as the choice of its predetermined programs directly on the homepage. Your work, simpler, faster, more efficient.



VIRTUAL CONSOLE

Thanks to the connectivity of the iPad-dedicated App, you can check Hyperion X9 even in a remote mode, by making use of a larger graphical interface and of intuitive icons. The 2D images are going to be viewable directly on the portable device by simplifying and further speeding up the sharing of the diagnostic investigation with the patient.

Fully iRYS.

Precision and speed. In less than a minute.
 Personalize your work with the best interface for your needs.
 More possibilities, maximum result.

The best software for your clinical needs. iRYS quickly elaborates all kinds of acquired data and enables you to browse around the different images. Try and generate panoramic scans, cephalometry and three-dimensional bone models. iRYS presents a multiple desktop management system so as to quickly visualize the images on the screen and effortlessly move from one page to the other.

The patient, too, will entertain no more doubts.
Speed at hand.

- Evolved image filters
- PiE (Panoramic image Enhancer)
- Implant simulation
- Compatibility with other software
- Data sharing with 2D and 3D Viewer

PRELOADED LIBRARIES

With the libraries, you are free to choose, free to create personalized models. For the sake of accurate diagnoses, precise in every detail.

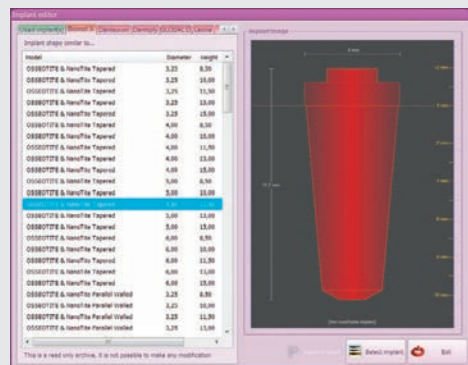

3D SMART

Implants/restorations with amalgam in the patient's mouth can cause shadows and streaks in volumetric images. The intelligent 3D SMART (Streak Metal Artifacts Reduction Technology) function efficiently reduces the typical metal-caused artifacts in 3D images.

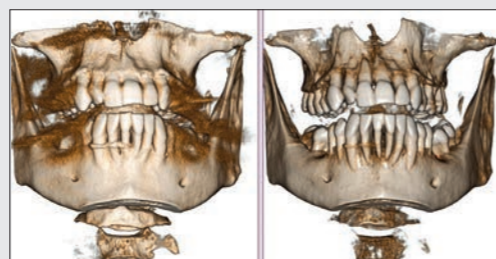

Full relax.

Sharing is trust. Hyperion X9 consolidates the clinical excellence of your practice by offering a quick and simple way of sharing every phase of the treatment with the patient.



Low radiogenic doses and full visual contact with the patient during the positioning. No walls, no panels, no mirrors, the maximum freedom of movement for you and for your patients. Hyperion X9 adopts this innovative formula so as to ensure serenity in your office and faster procedures. Relaxed environment and fast sharing for a more relaxed, optimal trust relationship. A serene patient is a collaborative patient, ready to choose his treatments more quickly.

Trust us. It's real.

- Clear information
- Fast sharing
- Involvement of the patient





Hyperion X9, improve your day.

Hyperion X9 evolves your work into a new dimension, optimizes your time, fulfils your needs. Exceptional high definition performances.

EASY WORK

Improves the quality of the clinical service, offering at once an answer to the problem by uninterruptedly monitoring the state of the patient during the treatment. More fluid work, more serene patient.

FULL CONNECTIVITY

The DICOM network connection is ensured thanks to protocols available with iRYS which enable to print, archive and retrieve images and to interface with booking lists.

PLUG&PLAY

Available applications for iPad for the sake of a Wi-Fi-driven remote control and quick and light diagnostics. Preparation, launch and image acquisition are within reach.

FULL HD

Expand your panoramic imaging to high definition, carry out the scan of the full dental arch in three dimensions. While respecting the patient, all with an extremely moderate X-ray dose.

HYBRID TECH

A hybrid platform, versatile and well-performing, which allows you to have all the diagnostic programs in a single device: 3D, PAN, CEPH. High diagnostic quality in a reduced space.

Technical characteristics.

3D IMAGES	EXTENDED FOV	FULL FOV
Detector technology	Amorphous Silicon – Csi (Cesium Iodide) Scintillator	
Dynamic range	16 bit (65535 grey shades)	
Minimum scan time	18 s	
Rotation	360°	
Image voxel size	75 µm (minimum slice thickness)	
Field of view, diameter x height	108x80 mm	108x50 mm
Available FOV sizes (Øxh)	11x13e - 11x8 - 8x8 - 11x5 - 8x5 - 5x5 cm	11x8e - 11x5 - 8x5 - 5x5cm
Largest size of image dataset	720 MB	450 MB
X-ray exposure time	3.6 s (High Resolution) - 9.0 s (Peak Resolution)	
Typical effective dose (ICRP 103): 11x8 FOV	33.5 µSv (High Resolution) – 78.6 µSv (Peak Resolution)	
Patient Alignment	Servo-assisted: "Scout View" method	
Image format	Exclusive iRYS and DICOM 3.0 software	
Minimum render times for CB3D data	15 s	

2D IMAGES	PANORAMIC	CEPHALOMETRY
Detector technology	CCD (CSI)	
Protection from direct X-ray exposure	FOP (Fibre Optics Plate)	
Pixel size	48 µm	
Dynamic range	14 bit (16383 Grey levels)	
Detector resolution	10.4 lp/mm	
Signal To Noise ratio	minimum 74 dB – typical 86 dB	
Detector height	146 mm	220 mm
Image pixel matrix	max: 1528x2797	max: 2291x3125
Maximum size of image file	8 MB	14 MB
X-ray exposure time	7.5 s - 13 s	3.4 s
Typical effective dose (ICRP 103)	4.3 - 6.7 µSv	5 µSv
Image resolution	from 5 to 7 lp/mm	
Image format	TIFF 16 bit, DICOM	
Patient Alignment	Servo-assisted: 4 laser guides	

X-RAY GENERATOR	
Generator type	Constant potential (DC)
X-ray emission type	pulsed, square shaped pulses
Anode voltage	60 – 90 kV (1kV step)
Anodic current	1 – 10 mA
Exposure time range	160 ms – 14 s (R10 scale)
Focal Spot dimension	0.5 mm (IEC 60336-1993)
Exposure Control Method	Automatic. MRT (Morphology Recognition Technology)
Compensation of Spine absorption	Automatic
mA and kV configuration	modulated in real time during X-ray exposure, automatically or manually selectable in steps of 1, in the whole kV range
Duty cycle	1:20 at full power (85 kV, 10 mA)
Inherent filtration	3.2 mm eq. Al (at 85kv)
Integrated X-ray shielding behind receptor	conforming to IEC60601-1-3

DIMENSIONS	PAN AND CB3D	WITH TELERADIOGRAPHIC ARM
Minimum required operation footprint (L x P)	1310x1520 mm	1830x1520 mm
Packed dimensions (H x L x P)	1515x1750x670 mm (crate)	822x1430x580 mm (box)
2 speed motorized column, adjustable height	1610 - 2400 mm	
Weight	170 Kg – 375 lbs	190 Kg – 419 lbs
Comments	Wall or floor support, free standing base available. Accessible for patients on wheelchair	

POWER SUPPLY SPECIFICATION	AUTOMATIC ADAPTATION FOR VOLTAGE AND FREQUENCY
Voltage Frequency	115 - 240 Vac, ± 10% single phase 50 / 60 Hz ± 2 Hz
Maximum current temporary peak absorption	15A a 115V, 7A a 240V
Current absorption in standby mode	maximum 1A

CONNECTIVITY	
Connections	LAN / Ethernet
Software	MyRay iRys
Supported protocols	DICOM 3.0, TWAIN, VDSS
DICOM nodes	IHE certification (Print; Storage Commitment; WorkList MPPS; Query Retrieve)

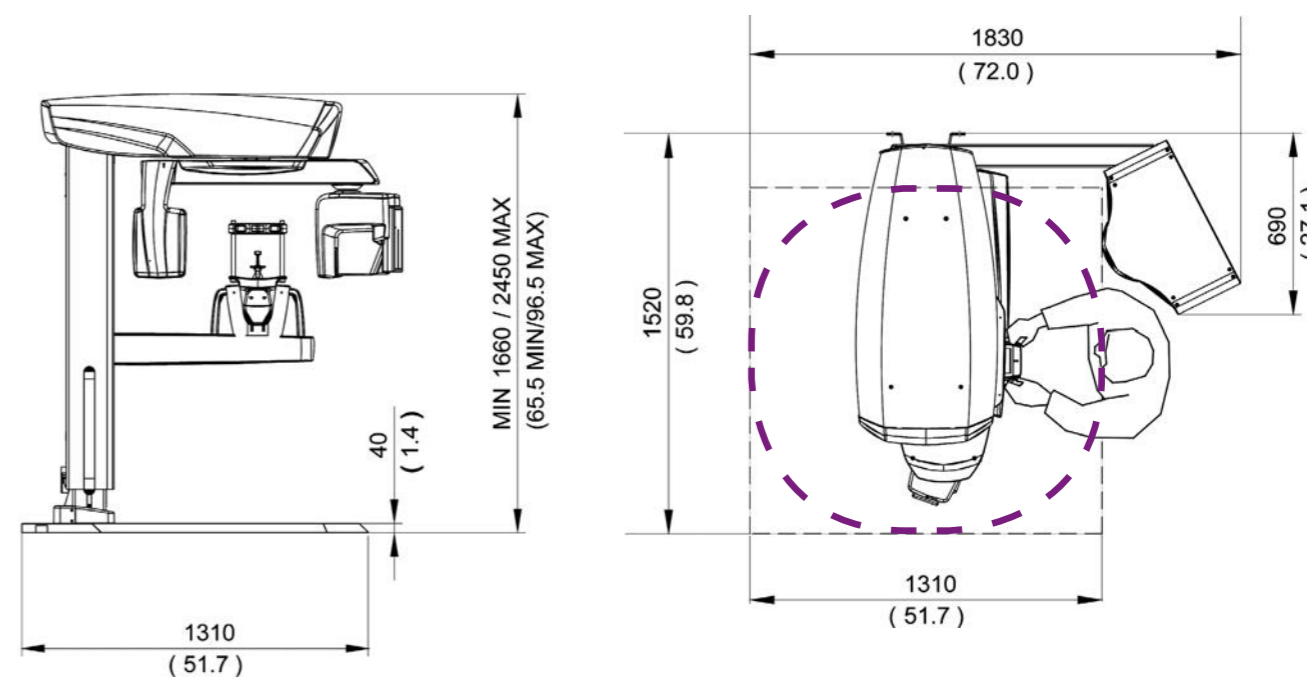

dimensions in millimetres (dimensions in inches)

MyRay, just right for you.

Leading European company for a full range of dental imaging solutions. For all dental practices.



RXDC
X-ray unit with HyperSphere technology.



RXDC
X-ray unit with eXTend technology.



RXDC
High frequency X-ray unit.



Hyperion X9
The extraoral 3-in-1 (3D, PAN, CEPH) imaging system suited to every clinic.



Hyperion X5
The compact and simple solution in the digital field of dental panoramic imaging.



X-pod
Wireless diagnostics within everyone's reach, fitted with a touch-sensitive display.



Zen-X
Direct USB HD intraoral sensor.



Hy-Scan
Phosphor Plate scanner.



iRYS
Best software for your 2D and 3D clinical needs.



C-U2
High Definition (HD) videocamera with the fastest communication in the world.



www.my-ray.com

Plant - Via Bicocca, 14/c - 40026 Imola - Bo (Italy) tel. +39 0542 653441 - fax +39 0542 653555

Headquarters - Cefla s.c. Via Selice Provinciale, 23/a - 40026 Imola - Bo (Italy) tel. +39 0542 653111 - fax +39 0542 653344

Cefla North America, Inc. 6125 Harris Technology Blvd. Charlotte, NC 28269 - U.S.A. Toll Free: (+1) 800.416.3078 Fax: (+1) 704.631.4609